

9,4KW

MANUELA

STUFA A PELLETT



A+

1.490 EUROS

SCARICO SUPERIORE O POSTERIORE



Finiture disponibili  
Available finishing  
Finitions  
Verkleidungen  
Acabados disponibles  
Zunanjosti, ki so na voljo



Rosso  
Red  
Rouge  
Rot  
Rojo  
Rdeča



Bianco  
White  
Blanc  
Weiss  
Blanco  
Bela



Nero gofrato  
Embossed black  
Noir gaufré  
Struktur schwarz  
Negro gofrado  
Reliefna črna

# 9,4KW

# MANUELA

## Dettagli tecnici-Technical details-Détails techniques-Technische Details-Detalles Técnicas-Tehnični podatki

Potencia consumida: Max 9,4 kw - Min 2,6 kw

Potencia calorífica: Max 8,5 kw - Min 2,5 kw

Clase de eficiencia energética: A+

Rendimiento: Pmax 90,5% - Pmin 95,5%

Valor de CO con 13% de O2: Pmax 0,004% - Pmin 0,045%

Consumo de pellet: Max 1,9 kg/h - Min 0,5 kg/h

Capacidad del depósito: 13,5 kg

Ambiente a calentar: 140 - 200 mc

Distancias mín. de paredes inflamables: Lado 15 cm - Trasero 5 cm - Frente 100 cm

Tensión de alimentación / Frec: 230V / 50 Hz

Potencia nominal eléctrica: 340 W

Peso: 90 kg

Cámara de combustión: Acero

Brasero: Acero inoxidable

Cumple con la normativa: EN14785 - BlmSchV II - LRV/VKF - 15a B-VG

Salida de humos: Trasera - Superior

Módulo WIFI para el control remoto: Opcional

Canalización Basic: Opcional

## Dimensioni-Dimensions-Mesures-Abmessung-Medidas- Mere

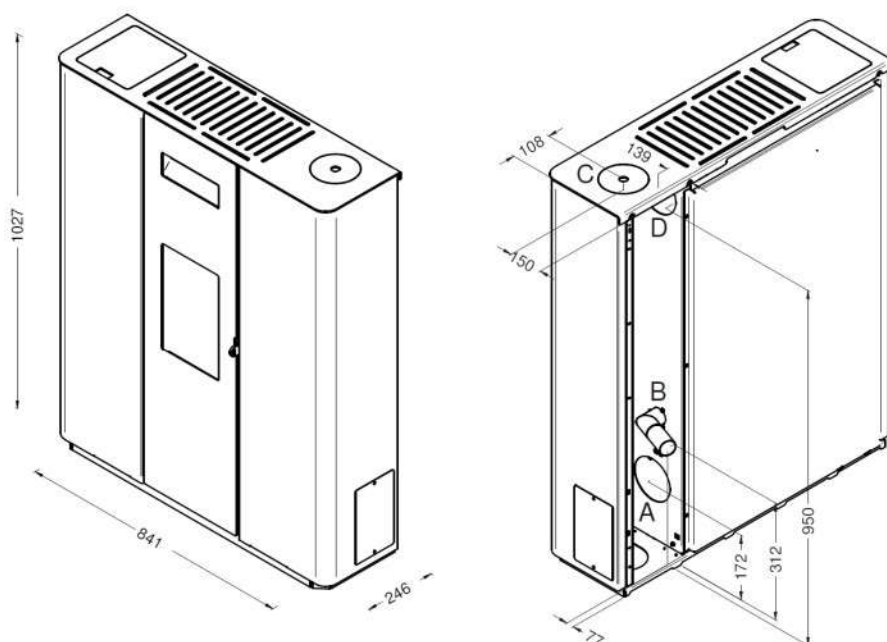

A = Ø 80 mm Scarico fumi / Flue / Cheminée / Rauchabzug / Evacuación de humos / Odvod dimnih plinov

B = Ø 40 mm Aria combustione / Combustion air / Air de combustion / Verbrennungsluft / Aire para la combustión / Zrak za zgorevanje

C = Ø 80 mm Scarico fumi superiore / Top Flue outlet / Sortie de Haut de Fumée / Top Abgasstutzen / Salida humos superior / Izpuh dimnih plinov zgoraj

D = Ø 80 mm Kit optional Aria canalizzata / Ducted air / Air pulse / Luftkanalsystem / Aire canalizado / Kanaliziran zrak

EVA STAMPAGGI S.r.l.

Via Cal Longa Z.I.

31028 Vazzola (TV) - ITALIA

tel. +39 0438 740433 - fax +39 0438 740821

info@puntofuoco.net - www.puntofuoco.net

